

# Potain Igo 36

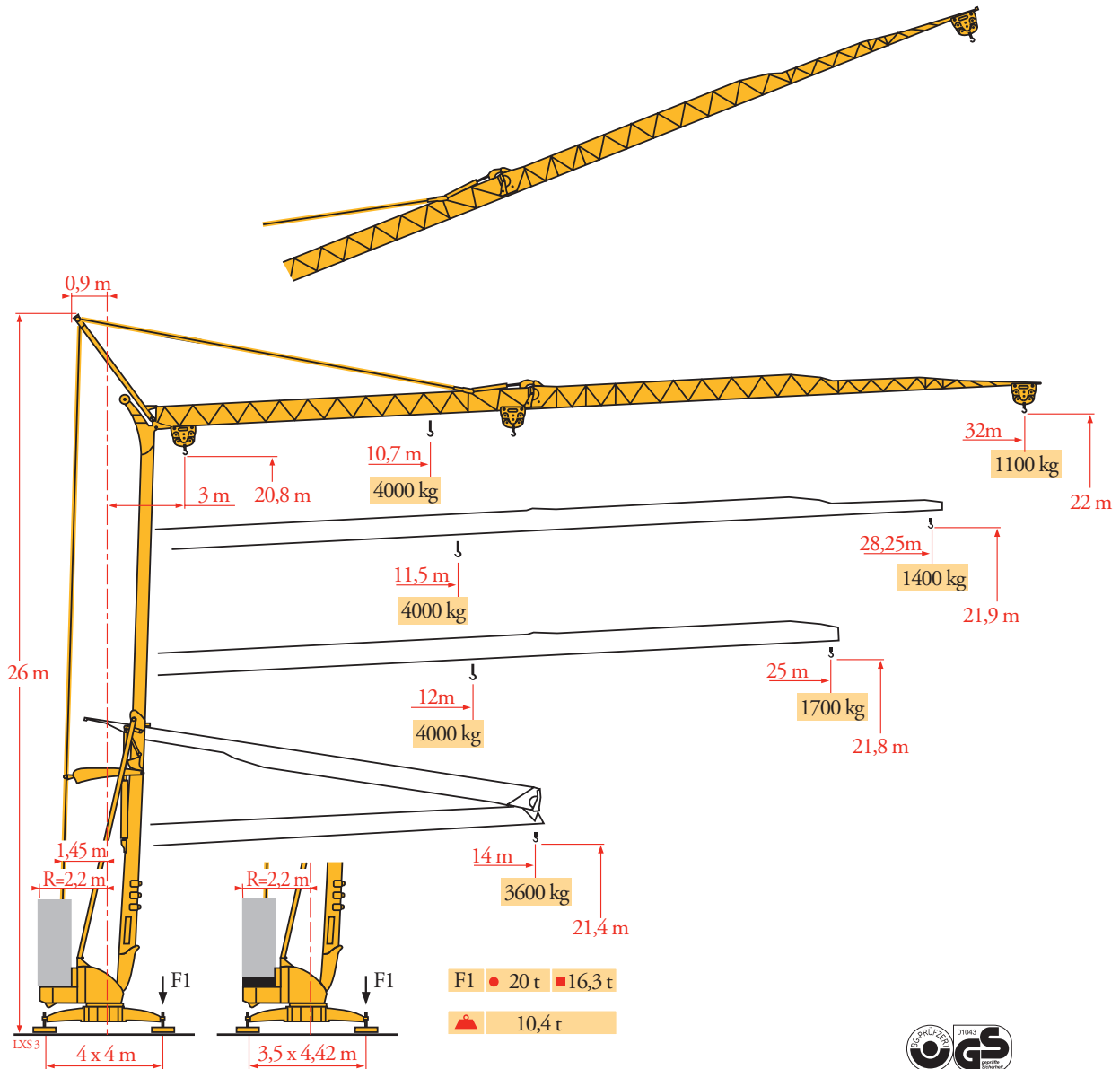

Courbes de charges  
Lastkurven  
Load diagrams  
Curvas de cargas  
Curve di carico  
Curva de cargas  
Диаграммы грузоподъемностей

LX5 3

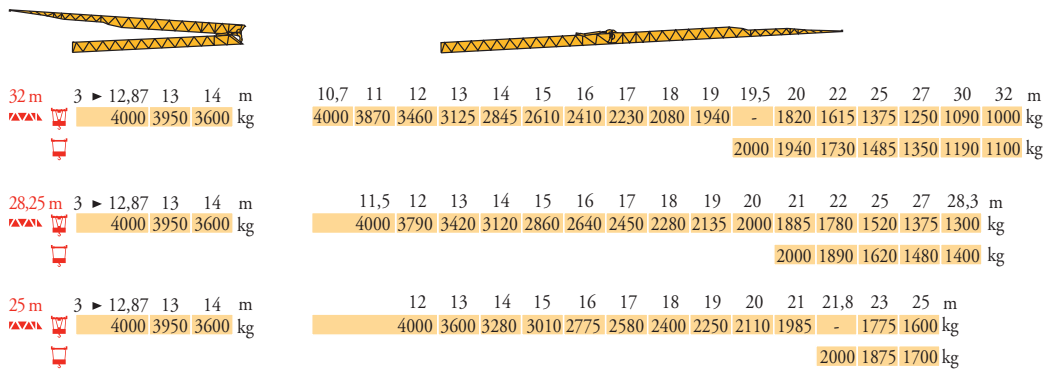

Flèche relevée  
Ausleger in Steilstellung  
Luffing jib  
Flecha izada  
Braccio impennato  
Lança inclinada  
Маховая стрела

LX5 3

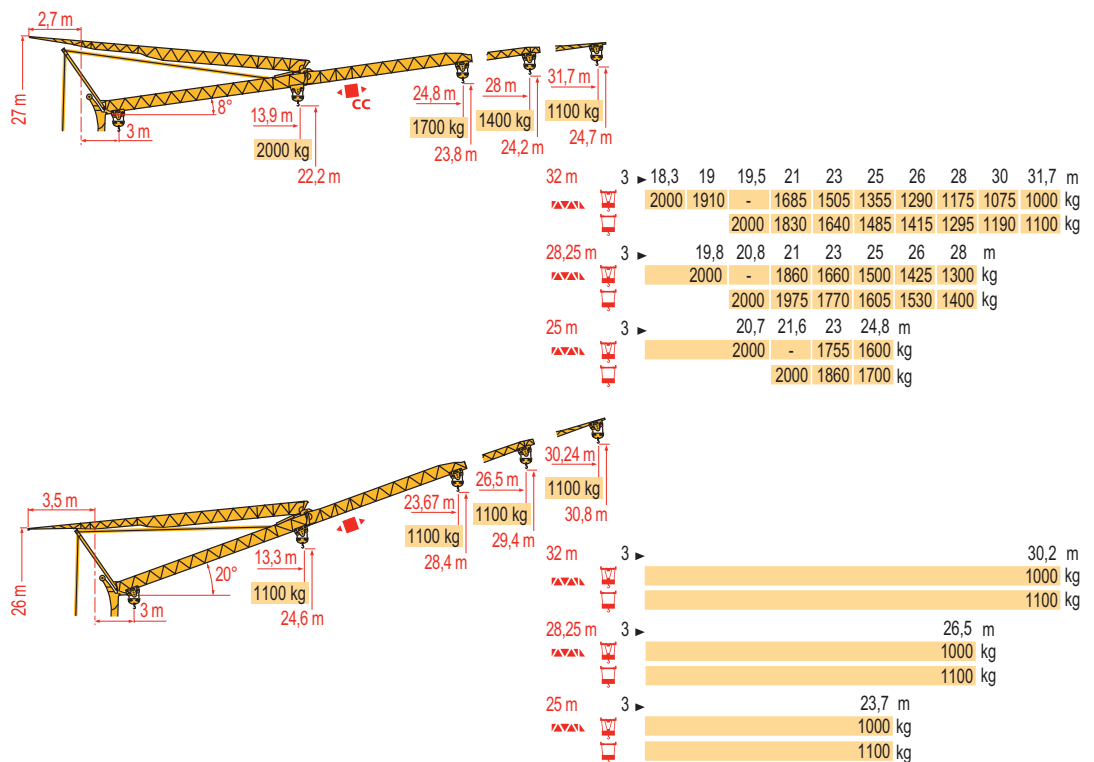

FR

Chariot distributeur  
Chariot distributeur et courbes de charges  
Réactions en service  
Réactions hors service

A vide sans lest (ni train de transport) avec flèche et hauteur maximum

DE

Verfahrbare Laufkatze  
Verfahrbare Laufkatze und Lastkurven  
Reaktionskräfte in Betrieb  
Reaktionskräfte außer Betrieb

Ohne Last, Ballast (und Transportachse), mit Maximalausleger und Maximalhöhe

EN

Traversing trolley  
Traversing trolley and load diagrams  
Reactions in service  
Reactions out of service

Without load, ballast (or transport axes), with maximum jib and maximum height

ES

Carro distribuidor  
Carro distribuidor y curvas de cargas  
Reacciones en servicio  
Reacciones fuera de servicio

Sin carga, sin lastre, (ni tren de transporte), flecha y altura máxima

IT

Carrellino distributore  
Carrellino distributore e curve di carico  
Reazioni in servizio  
Reazioni fuori servizio

A vuoto, senza zavorra (ne assali di trasporto) con braccio massimo e altezza massima

PT

Carro distribuidor  
Carro distribuidor e curva de cargas  
Reações em serviço  
Reações fora de serviço

Sem carga (nem trem de transporte) - sem lastro com lança e altura máximas

RU

Грузовая тележка  
Грузовая тележка и диаграммы грузоподъемностей  
Реакции при работе  
Реакции в покое

Вес без груза, балласта (или транспортных осей), с максимальной длиной стрелы и максимальной высотой

Mécanismes  
Antriebe  
Mechanisms  
Mecanismos  
Meccanismi  
Mecanismos  
Механизмы

LX5

		🗑️					🗑️					ch - PS hp	kW	
🔴	<b>15 LVF 10 Optima</b>	m/min	3,6	18	30	49	66						15	11
		kg	2000	2000	2000	1100	500							
		m/min	3,6	18	30	54	66	1,8	8,9	15	27	33		
		kg	2000	2000	2000	1000	500	4000	4000	4000	2000	1000		
🔴	<b>3 DVF5</b>	m/min	19 - 41									3	2,2	
🔴	<b>RVF+41</b>	tr/min U/min rpm	0 → 0,8									4	3	
		<b>CEI 38</b> ⚡	<b>IEC 38</b>				<b>kVA</b>							
		400 V (+6% -10%) 50 Hz					15 LVF 10 : 22 kVA							

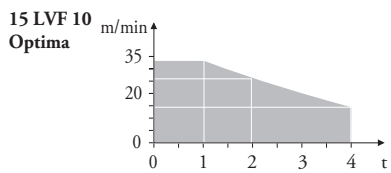

Montage  
Montage  
Erection  
Montaje  
Montaggio  
Montagem  
Монтаж

LX3

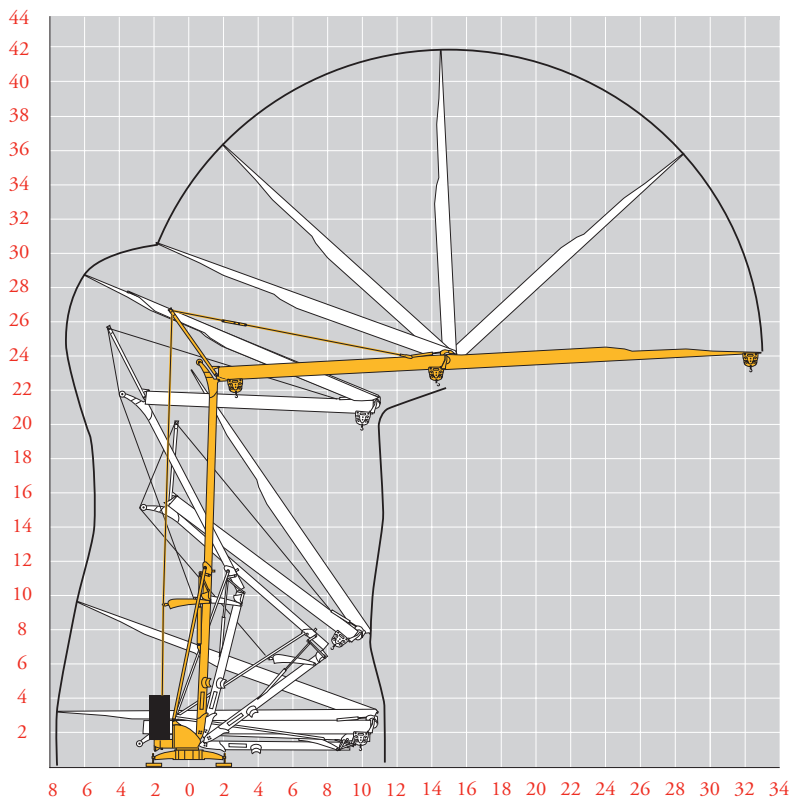

**FR**  
Levage  
Distribution  
Orientation

**DE**  
Heben  
Katzfahren  
Schwenken

**EN**  
Hoisting  
Trolleying  
Slewing

**ES**  
Elevación  
Distribución  
Orientación

**IT**  
Sollevamento  
Distribuzione  
Rotazione

**PT**  
Elevação  
Distribuição  
Rotação

**RU**  
Подъем  
Перемещение каретки  
Поворот

Transport  
Transport  
Transport  
Transporte  
Trasporto  
Transporte  
Транспортировка

LXS 4

		L (m)	B (m)	C (m)	D (m)	H (m)
DS61/S120	○					
DS61/S125	DS61/S120	15,9	2,45	3,73	7,08	3,05/3,2
DJ80/S120	○					
DJ80/S125	DJ80/S120	15,9	2,45	4,15	6,66	3,1
DJ100/S120	○					
DJ105/S125	DJ100/S120	16,33	2,45	4,15	6,66	3,23
DJ126M/S125	DJ105/S125	16,33	2,45	4,15	6,66	3,23
DJ126M/S125	DJ126M/S125	16,35	2,45	4,15	6,66	3,2
DJ126M/S215M	DJ126M/S215M	17,14	3,24	4,07	6,74	3,55

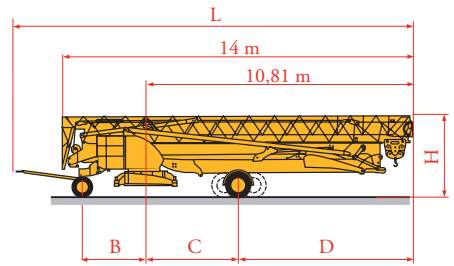

		C (m)	D (m)
SL122/J215M			
SL121/J135	SL122/J215M	4,07	6,74
SL121/S215M	SL121/J135	4	6,66
	SL121/S215M	4,07	6,74

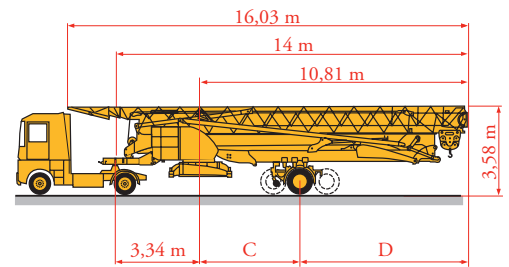

FR

○ Chantier

DE

Baustelle

EN

Site

ES

Obra

IT

Cantiere

PT

Estaleiro

RU

По строительной площадке



Document commercial non contractuel. Pour toute information technique se référer à la notice correspondante.

Unverbindliches Vertriebsdokument. Für technische Informationen, siehe die entsprechenden Anweisungen.

This commercial document is not legally binding. For any technical information, please refer to the corresponding instructions.

Documento commercial no contractual. Para cualquier información técnica, ver la noticia correspondiente.

Documento commerciale non vincolante, per tutte le informazioni tecniche fare riferimento al catalogo istruzioni.

Documento comercial não contratual. Para qualquer informação técnica complementar consultar as respectivas instruções.

Этот коммерческий документ не является юридически обязательным. Для получения технической информации, см. соответствующие инструкции.



**Manitowoc - Americas - World Headquarters**  
2400 S. 44th Street • Manitowoc • WI 54220 USA  
Tel: +1 920 684 4410 • Fax: +1 920 652 9778

**Manitowoc - Europe, Middle East & Africa**  
Manitowoc France SAS  
18, rue de Charbonnières B.P. 173 • 69132 ECULLY Cedex • FRANCE  
Tel: +33 (0)4 72 18 20 20 • Fax: +33 (0)4 72 18 20 00

**Manitowoc - Asia Pacific**  
16F Xu Hui Yuan Building,  
1089 Zhongshan No.2 Road (S) • Shanghai 200030 China  
Tel: +86 21 6457 0066 • Fax: +86 21 6457 4955

REF. 2003 48 LXS 7